

uni**pro**[®]

Making
your
lights
shine

PRODUCT CATALOGUE

2025





Making your lights shine

Unipro Oy Ltd with its parent company Meka Pro Ltd are both part of the privately owned Propria Group in Finland. Unipro (www.unipro.fi) is specialized in manufacturing high quality lighting track products. Unipro products are already sold in over 50 countries. New and modern factory is located in Hämeenlinna, Finland, close to all the main routes and harbours.

The unipro® lighting track system is a great and popular choice for offices, shopping centers, shops, museums, gyms and restaurants - only your imagination is the limit. It is a flexible solution for situations where the customer needs to increase or decrease the lighting space or re-arrange the lighting in general.

Unipro is the word for high quality products, modern design and smooth installation. The unipro® lighting track system offers flexibility in designing advanced lighting systems.

Our system includes surface and recessed 3-phase and Control-DALI lighting tracks, adapters and a wide range of mounting accessories.

Universal and modular design is easy to expand and adapt to the customer's wishes and requirements.

L-corners are adjustable and reversible with changeable earthing for fast and easy installation.

In fire-safety situations halogen-free lighting track parts will not release any flammable gases harmful for health. It is advisable to use halogen free products especially in premises full of people and challenging evacuation conditions.



Unipro has completed the carbon footprint study –
Please get in touch if you want to know more about our
carbon footprint report.



Green aluminium

In today's world, everyone is concerned about the environment and therefore industries and businesses are seeking innovative solutions to reduce their carbon footprint. One such method is the adoption of green aluminum, that promises a more sustainable future.

Unipro® is now offering green aluminum to those customers, who are requesting low-carbon footprint products. This green aluminum substantially reduces the carbon footprint. One ton of 100% recycled aluminum saves approximately 6 tons of bauxite and 9 tons of CO2 carbon emissions.



PVC halogen free products

What are halogens and why should you care? Elements like fluorine, chlorine, bromine, iodine and astatine are found in many chemical compounds like in PVC (polyvinylchloride). As we are aware of, PVC is used in many technical products to make them more durable. PVC is also used for insulation while other halogens are added to improve flame protection. However, halogens are harmful to human health. Particularly, in a situation where halogenated plastics and particularly PVC, burn. In a case of fire these halogens react with water or fluids and create a dangerous hydrochloric acid, other mixtures of dioxins and toxic chemicals. These can seriously damage health or even cause some mortalities.

This is why all Unipro connectors, adapters and 3-phase DALI tracks are manufactured completely using PVC- and Halogen free plastics.

Environmental product packaging

Humans are sinking the world with plastic. This is an enormous challenge for our environment. Therefore, unipro® has invested in a new automated track packaging line that enhances the productivity and offers individually packed tracks that are easy to transport and use at installation sites. The material is 30% recycled and recyclable plastic. On top of that all unipro® accessories are packaged in recycled cardboard that has helped unipro® reduce the use of plastic in packaging for over 1 tonne annually.



Helvar

Smart partners

Most recently Unipro has partnered with Helvar to offer their intelligent solutions to the 3-phase DALI track system. The new Helvar ActiveAhead® is a truly intelligent and scalable wireless lighting solution. Its unique self-learning capabilities give ultimate efficiency in setup and operations. ActiveAhead® will continuously learn and generate insights, maximising positive impact on wellbeing and optimising your ever-evolving building. Helvar ActiveAhead® is the perfect solution for offices, warehouses, stairways and parking garages.

Universal solutions

The unipro® lighting tracks are designed for surface and recessed installations. All unipro® tracks are compatible with most common adapters. Furthermore, unipro® tracks use Flat copper conductors that provide the best possible electrical contact with track adapters and require minimum work before installation.

The unipro® 3-phase adapters A79 (5 kg) and A90 (10 kg) are compatible with most 3-phase lighting tracks. Also the A90C (10 kg) 3-phase DALI adapter is suitable with most compatible DALI tracks in the market. The A200 Driver adapter family offers the latest technology with integrated drivers.

All connection units have reliable and easy-to-use screw terminals for 2.5mm² solid or braided wires. Power supply options are available on most of the connector pieces, such as MCU, L-corners, T-piece and X-unit.

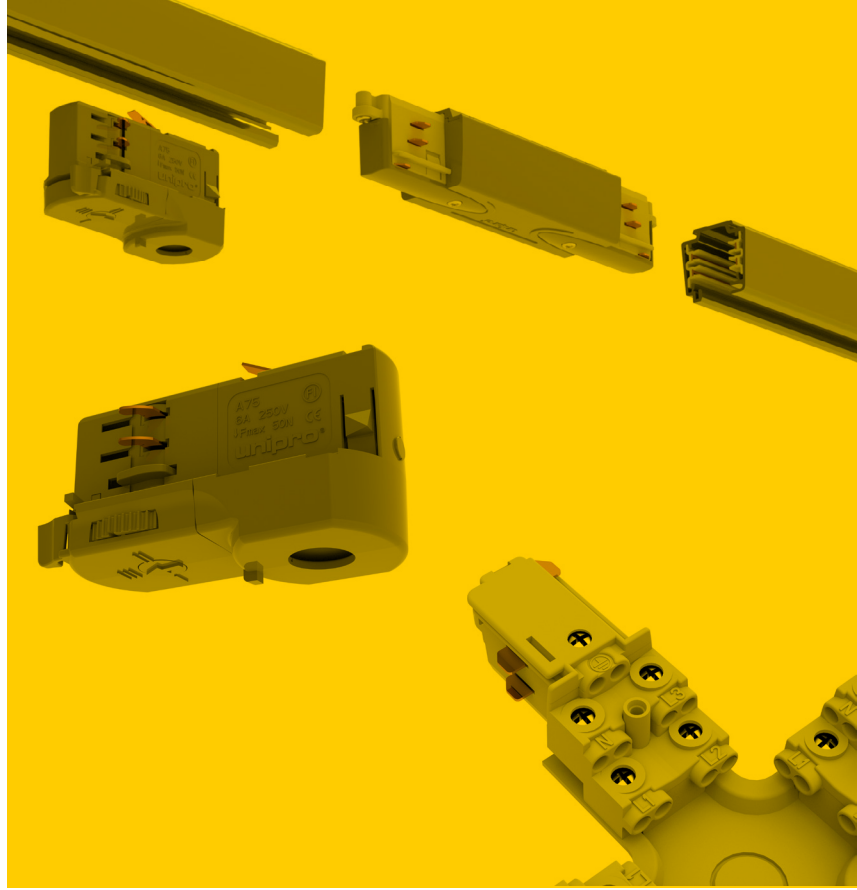

Wide selection of track lengths

Unipro offers a wide selection of track lengths suitable for various solutions. Lengths vary from 1,2 m to 4m and this allows the designers and architects to maximize the different possibilities in their design. We can also provide special requests as made-to-measure lengths accordingly.

Easy to install

The suspension parts for Unipro tracks can be used for all track products. They are easy to use and can be installed even without any special tools. Many wires are available also in white and black giving the suspended track solutions the perfect finish for your customer.



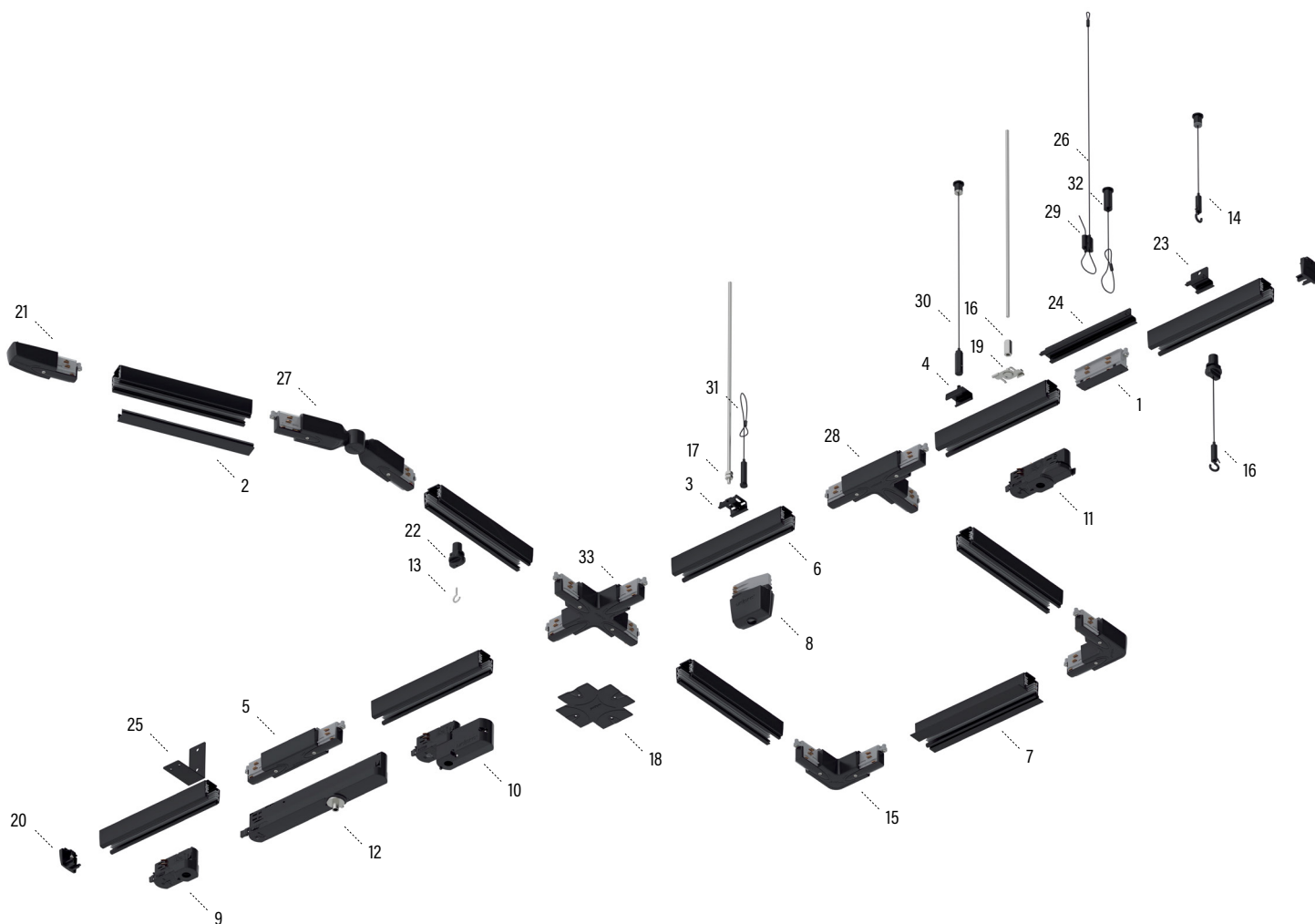

NO.	TYPE	ITEM	PAGE
1	Joining unit	UNIPRO JU3	8
2	Cover strip	UNIPRO CS3B	8
3	Ceiling bracket	UNIPRO CB3B	23
4	Quick ceiling bracket	UNIPRO QCB B	23
5	Middle connection unit	UNIPRO MCU3B	9
6	3-phase lighting track	UNIPRO T32B	6
7	3-phase lighting track, recessed	UNIPRO T32FB	7
8	Power outlet adapter	UNIPRO A100B	20
9	Luminaire adapter	UNIPRO A75B	18
10	Bluetooth control unit	UNIPRO A80BT B	20
11	Luminaire adapter	UNIPRO A90B	18
12	In-Track Driver adapter	UNIPRO A203B	19
13	Suspension hook	UNIPRO SH	27
14	Adjustable wire suspension set with hook	UNIPRO WS40H	22
15	L-corner	UNIPRO LC3B	9
16	Extension nut for threaded rod M6	JM M6 EG	27

NO.	TYPE	ITEM	PAGE
17	Nut for threaded rod M6	MU M6 EG	27
18	Cover plate	UNIPRO CP3B	8
19	Quick connector	UNIPRO QC3G	23
20	End cap	UNIPRO EC3B	8
21	Connection unit	UNIPRO CU3AB	9
22	Suspension clamp	UNIPRO SC3B	24
23	Pendant bracket	UNIPRO PB B	23
24	Pendant coupler	UNIPRO PC B	24
25	Wall bracket	UNIPRO WB B	24
26	Ø1,5 mm wire with loop	UNIPRO WL40 B	26
27	Adjustable corner	UNIPRO ALC3B	10
28	T-piece	UNIPRO TA3AB	10
29	Adjustable wire gripper	UNIPRO WG B	26
30	Adjustable wire suspension set	UNIPRO WS40 B	25
31	Adjustable wire set with loop wire	UNIPRO WS40L B	25
32	Adjustable wire set with loop wire	UNIPRO WSL40 B	25
33	X-piece	UNIPRO XA3B	10

LIGHTING TRACK FOR SURFACE INSTALLATION

16 A | 250/400 VAC | 50 Hz | CLASS I IP20

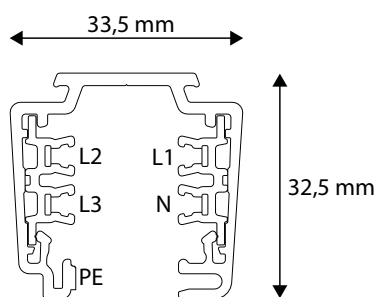
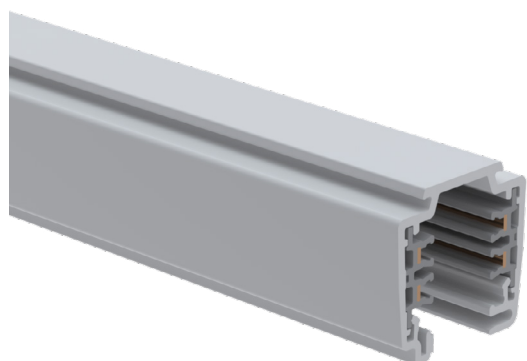

CODE	PRODUCT	WGT. kg / pce	LENGTH mm	COLOUR	PACKAGE
1459160	UNIPRO T312W	0.94	1200	White	4 PCE / 4.8 MTR
1459102	UNIPRO T32W	1.567	2000	White	4 PCE / 8 MTR
1459292	UNIPRO T324W	1.88	2400	White	4 PCE / 9.6 MTR
1459103	UNIPRO T33W	2.348	3000	White	4 PCE / 12 MTR
1459304	UNIPRO T34W	3.134	4000	White	4 PCE / 16 MTR
1459166	UNIPRO T312G	0.94	1200	Grey	4 PCE / 4.8 MTR
1459232	UNIPRO T32G	1.567	2000	Grey	4 PCE / 8 MTR
1459293	UNIPRO T324G	1.88	2400	Grey	4 PCE / 9.6 MTR
1459233	UNIPRO T33G	2.348	3000	Grey	4 PCE / 12 MTR
1459304	UNIPRO T34G	3.134	4000	Grey	4 PCE / 16 MTR
1459159	UNIPRO T312B	0.94	1200	Black	4 PCE / 4.8 MTR
1459302	UNIPRO T32B	1.567	2000	Black	4 PCE / 8 MTR
1459180	UNIPRO T324B	1.88	2400	Black	4 PCE / 9.6 MTR
1459303	UNIPRO T33B	2.348	3000	Black	4 PCE / 12 MTR
1459304	UNIPRO T34B	3.134	4000	Black	4 PCE / 16 MTR

RECESSED LIGHTING TRACK

16 A | 250/400 VAC | 50 Hz | CLASS 1 IP20

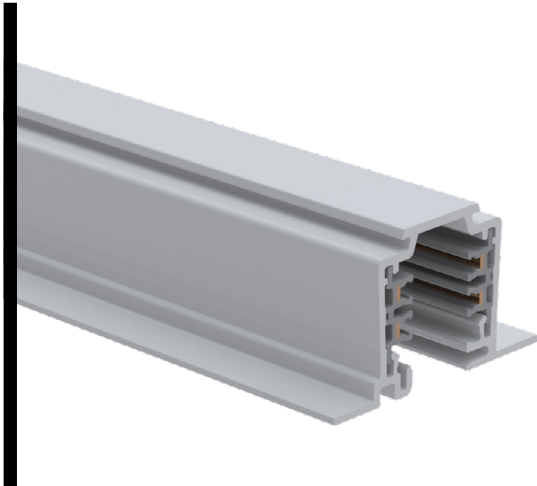

CODE	PRODUCT	WGT. kg / pce	LENGTH mm	COLOUR	PACKAGE
1459112	UNIPRO T32FW	1.785	2000	White	4 PCE / 8 MTR
1459114	UNIPRO T34FW	3.569	4000	White	4 PCE / 16 MTR
1459182	UNIPRO T32FG	1.785	2000	Grey	4 PCE / 8 MTR
1459184	UNIPRO T34FG	3.569	4000	Grey	4 PCE / 16 MTR
1459312	UNIPRO T32FB	1.785	2000	Black	4 PCE / 8 MTR
1459314	UNIPRO T34FB	3.569	4000	Black	4 PCE / 16 MTR

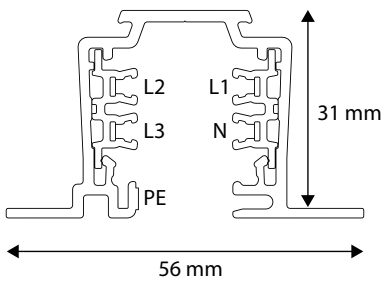

unipro® T3 lighting tracks

Materials	The lighting track frame is made of aluminium and the insulation is made of plastic. The phase and neutral wires are made of 2.5mm ² rectangular copper, protective earthing is achieved with the lighting track's aluminium frame. Surface treatment options are painted white (RAL9003), grey (RAL7040), black (RAL9005) and anodised natural colour. Other RAL Classic paint colours.
Wires	Three phase wires (L1, L2 and L3), neutral wire (N) and protective earthing (PE).
Protection class	Protection class 1 IP20
Quality and safety	Tested in compliance with EN60570 and EN60598.
Other	Can be cut to the appropriate length on site. Copper wires do not need to be bent or otherwise worked on after cutting.

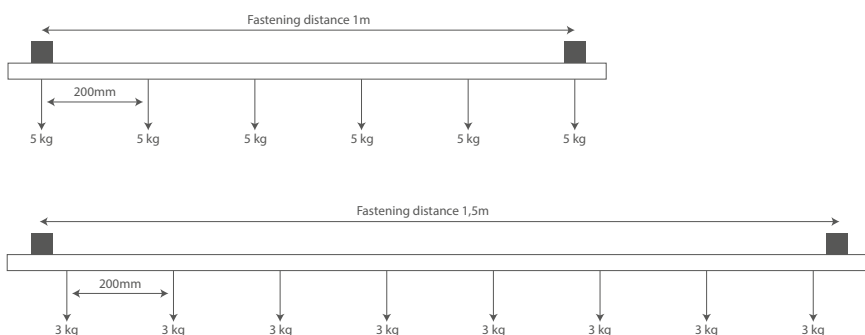

END CAP EC3

End cap for 3-phase lighting tracks.



ENR	PRODUCT	WGT. kg / pce	COLOUR	PACKAGE
1459181	UNIPRO EC3W	0.006	White	20 PCE / 1 BG
1459281	UNIPRO EC3G	0.006	Grey	20 PCE / 1 BG
1459381	UNIPRO EC3B	0.006	Black	20 PCE / 1 BG

COVER STRIP L=2M CS3

Cover strip for 3-phase and Control-DALI lighting tracks. Length 2m.

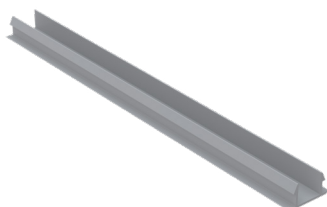

ENR	PRODUCT	WGT. kg / pce	COLOUR	PACKAGE
1459444	UNIPRO CS3W	0.125	White	8 PCE / 16 MTR
1459445	UNIPRO CS3B	0.125	Black	8 PCE / 16 MTR

COVER PLATE CP3

Cover plate for recessed lighting track systems, to cover the CU and MCU connection units as well as the L-, T- and X-pieces. Can be folded to the suitable shape during installation.

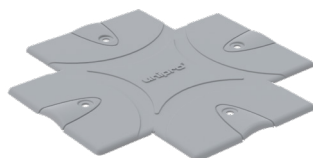

ENR	PRODUCT	WGT. kg / pce	COLOUR	PACKAGE
1459191	UNIPRO CP3W	0.017	White	5 PCE / 1 BG
1459291	UNIPRO CP3G	0.017	Grey	5 PCE / 1 BG
1459391	UNIPRO CP3B	0.017	Black	5 PCE / 1 BG

JOINTING UNIT JU3

Jointing unit for 3-phase lighting tracks. Product comes with grey and black covers. A cover can be installed by pressing it on top of the jointing unit.

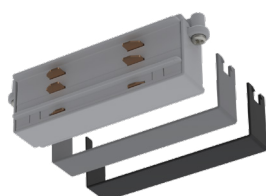

ENR	PRODUCT	WGT. kg / pce	PACKAGE
1459199	UNIPRO JU3	0.043	10 PCE / BG

CONNECTION UNIT CU3

Power supply option for 3-phase lighting track systems. Two earthing options. Screw terminals for $3 \times 1.5\text{mm}^2 - 5 \times 2.5\text{mm}^2$ wires.

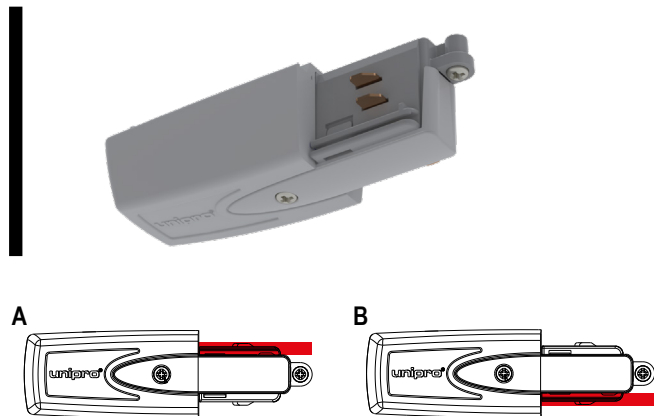

Please note! Earthing pictures taken from below.

ENR	PRODUCT	WGT. kg / pce	COLOUR	PACKAGE
1459121	UNIPRO CU3AW	0.058	White	10 PCE / 1 BG
1459221	UNIPRO CU3AG	0.058	Grey	10 PCE / 1 BG
1459321	UNIPRO CU3AB	0.058	Black	10 PCE / BG
1459122	UNIPRO CU3BW	0.058	White	10 PCE / 1 BG
1459222	UNIPRO CU3BG	0.058	Grey	10 PCE / 1 BG
1459322	UNIPRO CU3BB	0.058	Black	10 PCE / 1 BG

MIDDLE CONNECTION UNIT MCU3

Power supply option for 3-phase lighting track systems. Screw terminals for $3 \times 1.5\text{mm}^2 - 5 \times 2.5\text{mm}^2$ wires.



ENR	PRODUCT	WGT. kg / pce	COLOUR	PACKAGE
1459131	UNIPRO MCU3W	0.104	White	8 PCE / 1 BG
1459231	UNIPRO MCU3G	0.104	Grey	8 PCE / 1 BG
1459331	UNIPRO MCU3B	0.104	Black	8 PCE / 1 BG

L-CORNER LC3

Power supply option for 3-phase lighting track systems. Changeable earthing line position. Screw terminals for $3 \times 1.5\text{mm}^2 - 5 \times 2.5\text{mm}^2$ wires.

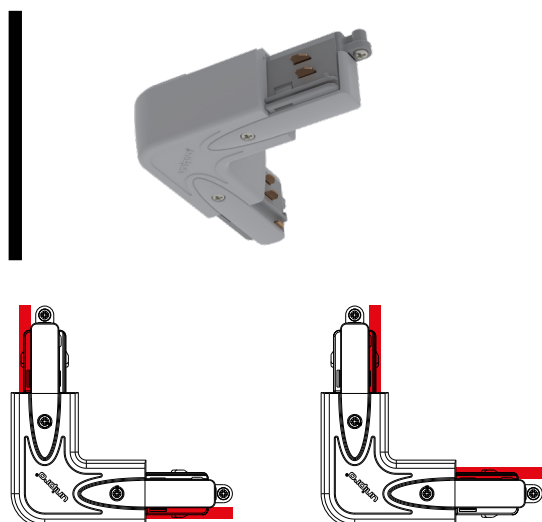

Please note! Earthing pictures taken from below.

ENR	PRODUCT	WGT. kg / pce	COLOUR	PACKAGE
1459141	UNIPRO LC3W	0.105	White	6 PCE / 1 BG
1459241	UNIPRO LC3G	0.105	Grey	6 PCE / 1 BG
1459341	UNIPRO LC3B	0.105	Black	6 PCE / 1 BG

ADJUSTABLE CORNER ALC3

Horizontal adjustment range $0 \pm 120^\circ$.

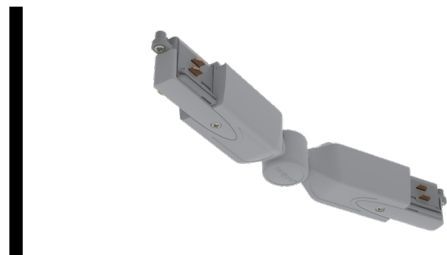

ENR	PRODUCT	WGT. kg / pce	COLOUR	PACKAGE
1459151	UNIPRO ALC3W	0.13	White	4 PCE / 1 BG
1459251	UNIPRO ALC3G	0.13	Grey	4 PCE / 1 BG
1459351	UNIPRO ALC3B	0.13	Black	4 PCE / 1 BG

T-PIECE TA3

Power supply option for 3-phase lighting track systems. Four earthing options.
Screw terminals for $3 \times 1.5\text{mm}^2$ - $5 \times 2.5\text{mm}^2$ wires.

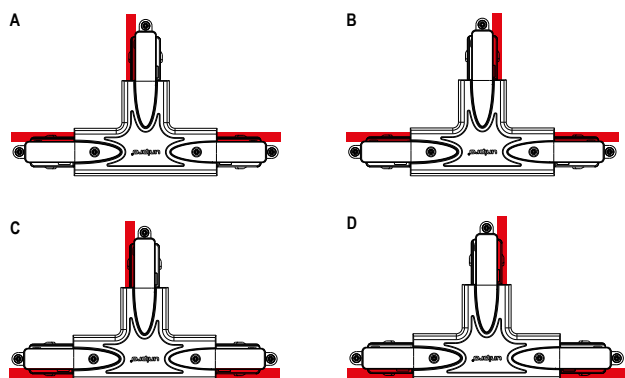
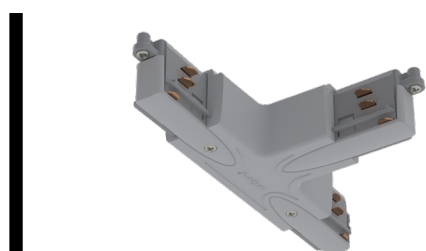

Please note! Earthing pictures taken from below.

ENR	PRODUCT	WGT. kg / pce	COLOUR	PACKAGE
1459161	UNIPRO TA3AW	0.15	White	4 PCE / 1 BG
1459261	UNIPRO TA3AG	0.15	Grey	4 PCE / 1 BG
1459361	UNIPRO TA3AB	0.15	Black	4 PCE / 1 BG

1459162	UNIPRO TA3BW	0.15	White	4 PCE / 1 BG
1459262	UNIPRO TA3BG	0.15	Grey	4 PCE / 1 BG
1459362	UNIPRO TA3BB	0.15	Black	4 PCE / 1 BG

1459163	UNIPRO TA3CW	0.15	White	4 PCE / 1 BG
1459263	UNIPRO TA3CG	0.15	Grey	4 PCE / 1 BG
1459363	UNIPRO TA3CB	0.15	Black	4 PCE / 1 BG

1459164	UNIPRO TA3DW	0.15	White	4 PCE / 1 BG
1459264	UNIPRO TA3DG	0.15	Grey	4 PCE / 1 BG
1459364	UNIPRO TA3DB	0.15	Black	4 PCE / 1 BG

X-PIECE XA3

Power supply option for 3-phase lighting track systems. Screw terminals for $3 \times 1.5\text{mm}^2$ - $5 \times 2.5\text{mm}^2$ wires.

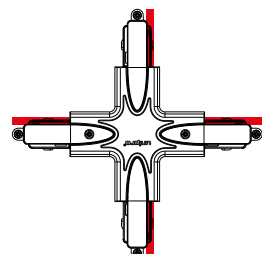
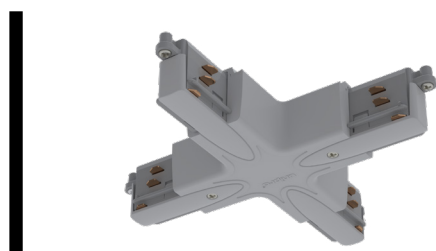

Please note! Earthing pictures taken from below.

ENR	PRODUCT	WGT. kg / pce	COLOUR	PACKAGE
1459171	UNIPRO XA3W	0.196	White	2 PCE / 1 BG
1459271	UNIPRO XA3G	0.196	Grey	2 PCE / 1 BG
1459371	UNIPRO XA3B	0.196	Black	2 PCE / 1 BG

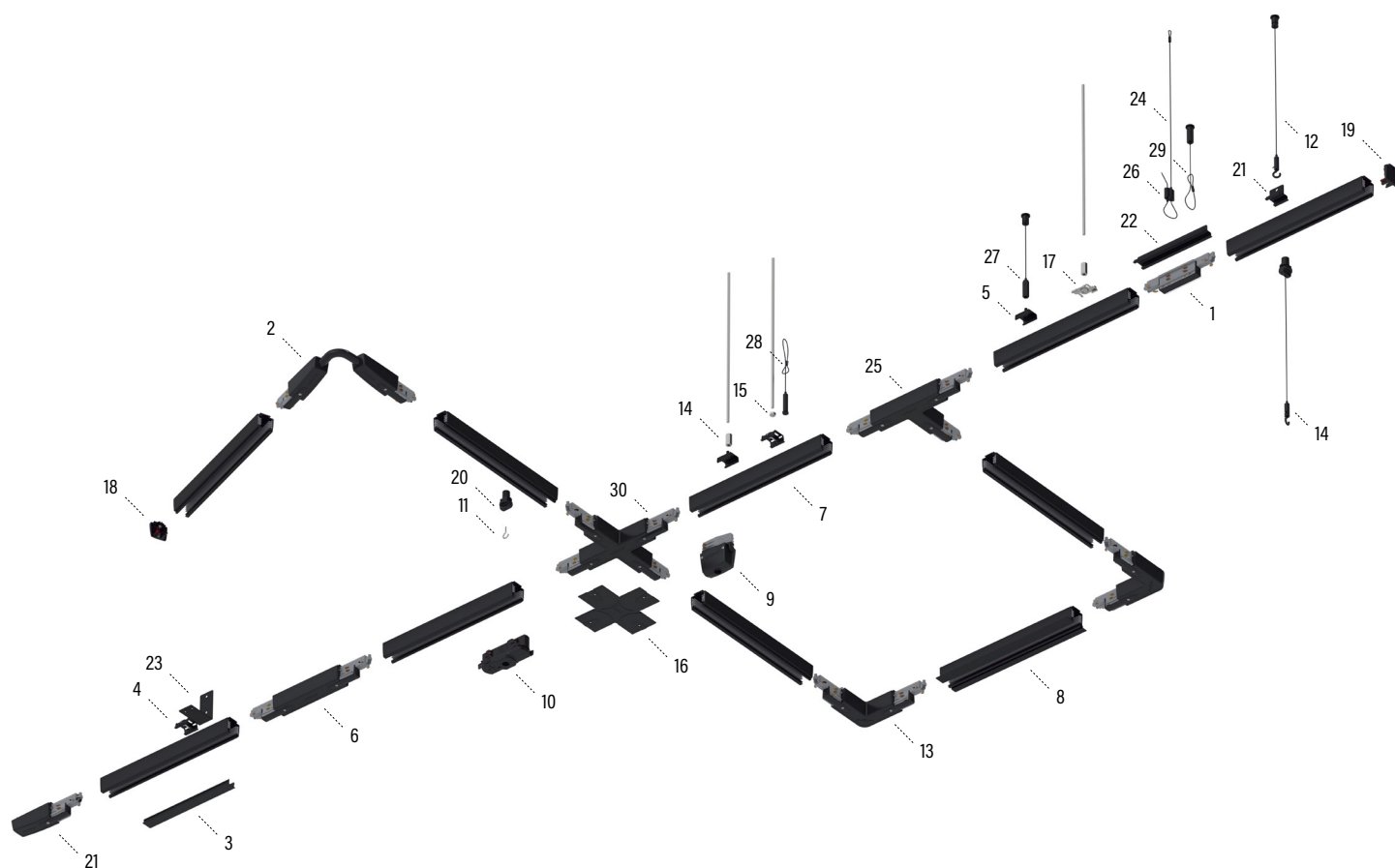

NO.	TYPE	ITEM	PAGE
1	Control-DALI Jointing unit	UNIPRO CJU3	15
2	Control-DALI Adjustable corner	UNIPRO CFC3 B	15
3	Cover strip L=2m	UNIPRO CS3B	14
4	Ceiling bracket	UNIPRO CB3B	23
5	Quick ceiling bracket	UNIPRO QCB B	23
6	Control-DALI Middle connection unit	UNIPRO CMCU3B	15
7	Control-DALI lighting track	UNIPRO TC32B	12
8	Control-DALI lighting track, recessed	UNIPRO TC32FB	13
9	Power outlet adapter	UNIPRO A100B	20
10	Control-DALI Luminaire adapter	UNIPRO A90CB	18
11	Suspension hook	UNIPRO SH	27
12	Adjustable wire suspension set with hook	UNIPRO WS40H	25
13	Control-DALI L-corner	UNIPRO CLC3B	16
14	Extension nut for threaded rod M6	JM M6 EG	27
15	Nut for threaded rod M6	MU M6 EG	27

NO.	TYPE	ITEM	PAGE
16	Control-DALI Cover plate	UNIPRO CCP3 B	14
17	Quick connector	UNIPRO QC3G	23
18	Control-DALI End cap	UNIPRO CEC3B	14
19	Control-DALI Connection unit	UNIPRO CCU3AB	15
20	Suspension clamp	UNIPRO SC3B	24
21	Pendant bracket	UNIPRO PB B	23
22	Pendant coupler	UNIPRO PC B	24
23	Wall bracket	UNIPRO WB B	24
24	Ø1,5 mm wire with loop	UNIPRO WL40 B	26
25	Control-DALI T-piece	UNIPRO CTA3AB	16
26	Adjustable wire gripper	UNIPRO WG B	26
27	Adjustable wire suspension set	UNIPRO WS40 B	25
28	Adjustable wire set with loop wire	UNIPRO WS40L B	25
29	Adjustable wire set with loop wire	UNIPRO WSL40 B	25
30	Control-DALI X-piece	UNIPRO CXA3B	17

CONTROL-DALI LIGHTING TRACK FOR SURFACE INSTALLATION

Control-DALI lighting track for surface installation.

16 A, (250/400) VAC, 50 Hz, FELV ≤ 50VAC ≤ 1A, CLASS 1 IP20.

Free of halogens and PVCs.

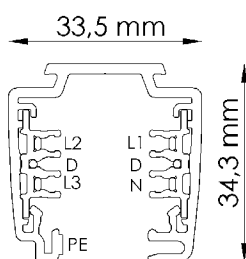
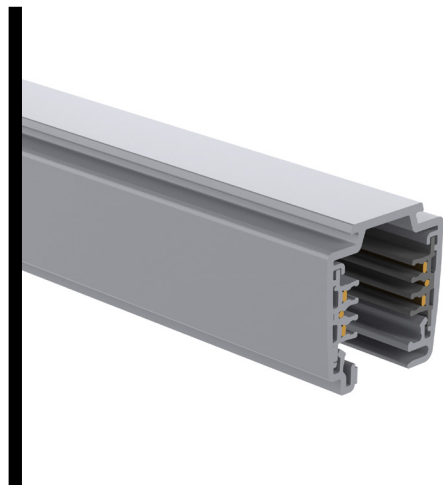

CODE	PRODUCT	WGT. kg / pce	LENGTH mm	COLOUR	PACKAGE
1459243	UNIPRO TC312W	1.075	1200	White	4 PCE / 4.8 MTR
1459107	UNIPRO TC32W	1.792	2000	White	4 PCE / 8 MTR
1459253	UNIPRO TC324W	2.15	2400	White	4 PCE / 9.6 MTR
1459108	UNIPRO TC33W	2.763	3000	White	4 PCE / 12 MTR
1459109	UNIPRO TC34W	3.684	4000	White	4 PCE / 16 MTR
1459294	UNIPRO TC312G	1.075	1200	Grey	4 PCE / 4.8 MTR
1459237	UNIPRO TC32G	1.792	2000	Grey	4 PCE / 8 MTR
1459254	UNIPRO TC324G	2.15	2400	Grey	4 PCE / 9.6 MTR
1459238	UNIPRO TC33G	2.763	3000	Grey	4 PCE / 12 MTR
1459239	UNIPRO TC34G	3.684	4000	Grey	4 PCE / 16 MTR
1459242	UNIPRO TC312B	1.075	1200	Black	4 PCE / 4.8 MTR
1459307	UNIPRO TC32B	1.792	2000	Black	4 PCE / 8 MTR
1459250	UNIPRO TC324B	2.15	2400	Black	4 PCE / 9.6 MTR
1459308	UNIPRO TC33B	2.763	3000	Black	4 PCE / 12 MTR
1459309	UNIPRO TC34B	3.684	4000	Black	4 PCE / 16 MTR

RECESSED UNIPRO CONTROL-DALI LIGHTING TRACK

Control-DALI lighting track for recessed installation.
 16 A, (250/400) VAC, 50Hz, FELV ≤ 50VAC ≤ 1A, CLASS 1 IP20.
 Free of halogens and PVCs.

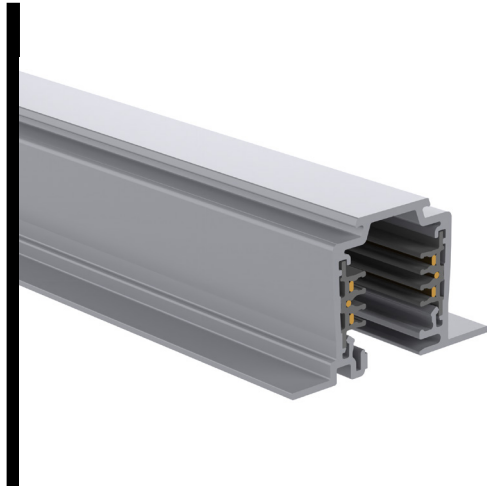

CODE	PRODUCT	WGT. kg / pce	LENGTH mm	COLOUR	PACKAGE
1459117	UNIPRO TC32FW	2.064	2000	White	4 PCE / 8 MTR
1459119	UNIPRO TC34FW	4.228	4000	White	4 PCE / 16 MTR
1459187	UNIPRO TC32FG	2.064	2000	Grey	4 PCE / 8 MTR
1459189	UNIPRO TC34FG	4.228	4000	Grey	4 PCE / 16 MTR
1459317	UNIPRO TC32FB	2.064	2000	Black	4 PCE / 8 MTR
1459319	UNIPRO TC34FB	4.228	4000	Black	4 PCE / 16 MTR

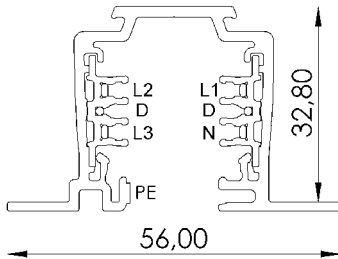

unipro® Control-DALI TC3 lighting tracks

Control-DALI

Materials	The lighting track frame is made of aluminium and the insulation is made of halogen and PVC-free plastic. The phase and neutral wires are made of 2.5mm ² flat copper, control wires are made of 1.5mm ² round copper. Protective earthing is achieved with the lighting track's aluminium frame. Surface treatment options are painted white (RAL9003), grey (RAL7040), black (RAL9005) and anodised natural colour. Other RAL Classic paint colours are possible with custom orders.
Wires	Three phase wires (L1, L2 and L3), neutral wire (N), protective earthing (PE) and data wires (D).
Protection class	Protection class 1 IP20
Quality and safety	Tested in compliance with EN60570 and EN60598.
Other	Can be cut to the appropriate length on site. Phase wires must be shortened by 5mm with TCCP copper cutting pliers.

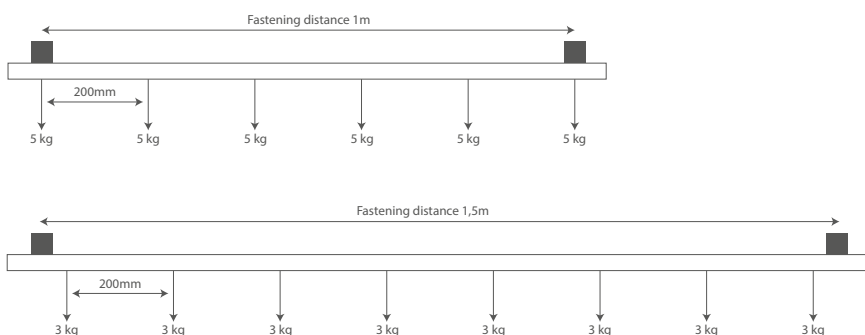

COPPER CUTTING PLIERS FOR CONTROL-DALI TRACKS TCCP

Control-DALI lighting tracks' L1, L2, L3 and N wires need to be shortened 5mm after cutting the lighting track so that the required electrical and safety clearances and distances are fulfilled.



CODE	PRODUCT	WGT. kg / pce	LENGTH mm	PACKAGE
1459190	UNIPRO TCCP	0.2	250	1 PCE

CONTROL-DALI END CAP CEC3

End cap for Control-DALI lighting tracks.



CODE	PRODUCT	WGT. kg / pce	COLOUR	PACKAGE
1459196	UNIPRO CEC3W	0.006	White	20 PCE / 1 BG
1459285	UNIPRO CEC3G	0.006	Grey	20 PCE / 1 BG
1459385	UNIPRO CEC3B	0.006	Black	20 PCE / 1 BG

COVER STRIP L=2M CS3

Cover strip for 3-phase and Control-DALI lighting tracks. Length 2m.

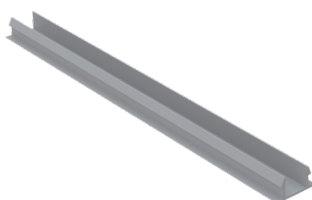

CODE	PRODUCT	WGT. kg / pce	COLOUR	PACKAGE
1459444	UNIPRO CS3W	0.125	White	1 PCE / 2 MTR
1459445	UNIPRO CS3B	0.125	Black	1 PCE / 2 MTR

CONTROL-DALI COVER PLATE CCP3

Cover plate for recessed Control-DALI lighting track systems, to cover the CCU and CMCU connection units as well as the L-, T- and X-pieces. Can be folded to the suitable shape during installation.

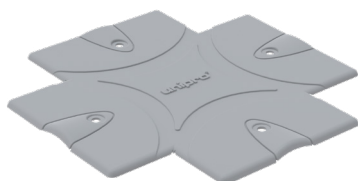

CODE	PRODUCT	WGT. kg / pce	COLOUR	PACKAGE
1459101	UNIPRO CCP3 W	0.028	White	5 PCE / 1 BG
1459111	UNIPRO CCP3 B	0.028	Black	5 PCE / 1 BG
1459120	UNIPRO CCP3 G	0.028	Grey	5 PCE / 1 BG

CONTROL-DALI JOINTING UNIT CJU3

Jointing unit for Control-DALI lighting track systems. Product comes with grey and black covers. A cover can be installed by pressing it on top of the jointing unit.

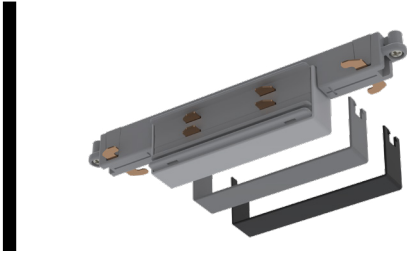

CODE	PRODUCT	WGT. kg / pce	PACKAGE
1459198	UNIPRO CJU3	0.053	8 PCE / 1 BG

CONTROL-DALI CONNECTION UNIT CCU3

Power supply option for Control-DALI track systems. Two earthing options. Screw terminals for 1.5mm² - 2.5mm² wires.



CODE	PRODUCT	WGT. kg / pce	COLOUR	PACKAGE
1459125	UNIPRO CCU3AW	0.079	White	8 PCE / 1 BG
1459225	UNIPRO CCU3AG	0.079	Grey	8 PCE / 1 BG
1459325	UNIPRO CCU3AB	0.079	Black	8 PCE / 1 BG

1459126	UNIPRO CCU3BW	0.079	White	8 PCE / 1 BG
1459226	UNIPRO CCU3BG	0.079	Grey	8 PCE / 1 BG
1459326	UNIPRO CCU3BB	0.079	Black	8 PCE / 1 BG

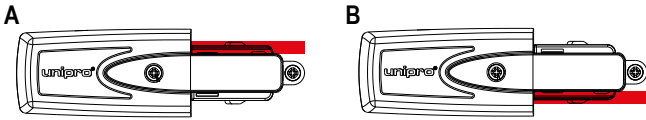

Please note! Earthing pictures taken from below.

CONTROL-DALI MIDDLE CONNECTION UNIT CMCU3

Power supply option for Control-DALI track systems. Screw terminals for 1.5mm² - 2.5mm² wires.



CODE	PRODUCT	WGT. kg / pce	COLOUR	PACKAGE
1459129	UNIPRO CMCU3W	0.159	White	5 PCE / 1 BG
1459228	UNIPRO CMCU3G	0.159	Grey	5 PCE / 1 BG
1459335	UNIPRO CMCU3B	0.159	Black	5 PCE / 1 BG

CONTROL-DALI ADJUSTABLE CORNER CFC

Power supply option for Control-DALI track systems. Screw terminals for 1.5mm² - 2.5mm² wires.

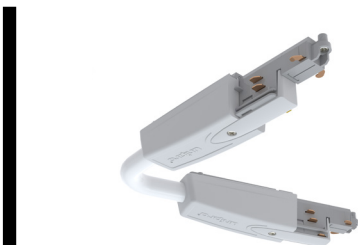

CODE	PRODUCT	WGT. kg / pce	COLOUR	PACKAGE
1459154	UNIPRO CFC3 W	0.2	White	1 PCE
1459152	UNIPRO CFC3 B	0.2	Black	1 PCE

CONTROL-DALI L-CORNER CLC3

Power supply option for Control-DALI track systems. Changeable earthing line position. Screw terminals for 1.5mm² - 2.5mm² wires.



CODE	PRODUCT	WGT. kg / pce	COLOUR	PACKAGE
1459153	UNIPRO CLC3W	0.158	White	4 PCE / 1 BG
1459245	UNIPRO CLC3G	0.158	Grey	4 PCE / 1 BG
1459345	UNIPRO CLC3B	0.158	Black	4 PCE / 1 BG

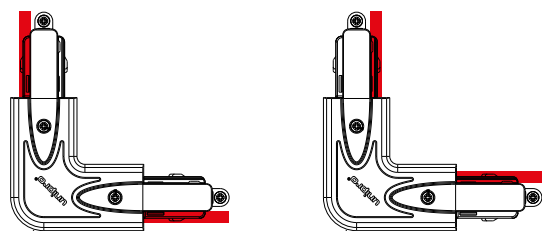

Please note! Earthing pictures taken from below.

CONTROL-DALI T-PIECE CTA3

Power supply option for Control-DALI track systems. Four earthing options. Screw terminals for 1.5mm² - 2.5mm² wires.

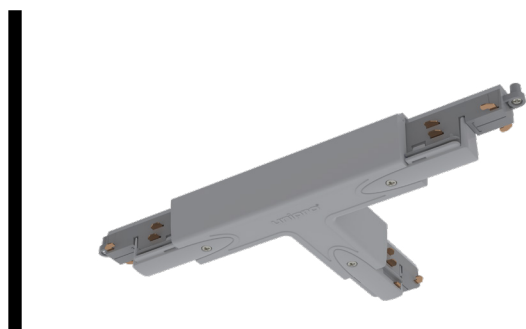

CODE	PRODUCT	WGT. kg / pce	COLOUR	PACKAGE
1459155	UNIPRO CTA3AW	0.24	White	2 PCE / 1 BG
1459255	UNIPRO CTA3AG	0.24	Grey	2 PCE / 1 BG
1459355	UNIPRO CTA3AB	0.24	Black	2 PCE / 1 BG
1459156	UNIPRO CTA3BW	0.24	White	2 PCE / 1 BG
1459256	UNIPRO CTA3BG	0.24	Grey	2 PCE / 1 BG
1459356	UNIPRO CTA3BB	0.24	Black	2 PCE / 1 BG
1459157	UNIPRO CTA3CW	0.24	White	2 PCE / 1 BG
1459257	UNIPRO CTA3CG	0.24	Grey	2 PCE / 1 BG
1459357	UNIPRO CTA3CB	0.24	Black	2 PCE / 1 BG
1459158	UNIPRO CTA3DW	0.24	White	2 PCE / 1 BG
1459258	UNIPRO CTA3DG	0.24	Grey	2 PCE / 1 BG
1459358	UNIPRO CTA3DB	0.24	Black	2 PCE / 1 BG

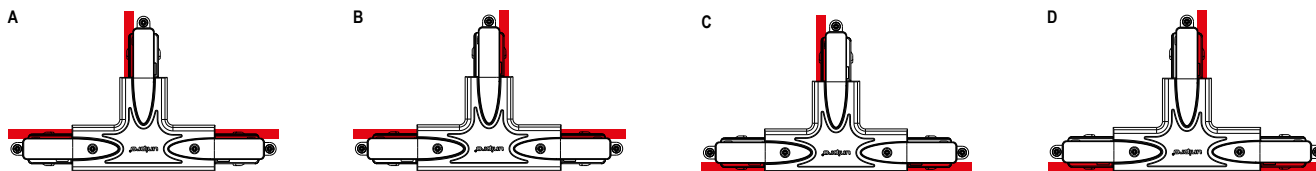

Please note! Earthing pictures taken from below.

CONTROL-DALI X-PIECE CXA3

Power supply option for Control-DALI track systems. Screw terminals for 1.5mm² - 2.5mm² wires.

unipro®

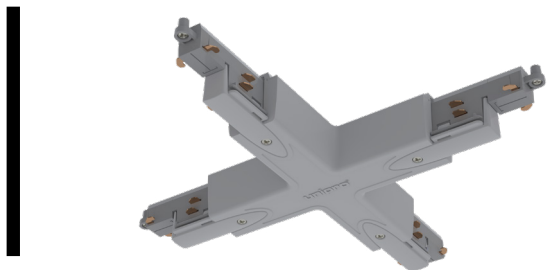

CODE	PRODUCT	WGT. kg / pce	COLOUR	PACKAGE
1459167	UNIPRO CXA3W	0.323	White	1 PCE / 1 BG
1459275	UNIPRO CXA3G	0.323	Grey	1 PCE / 1 BG
1459375	UNIPRO CXA3B	0.323	Black	1 PCE / 1 BG

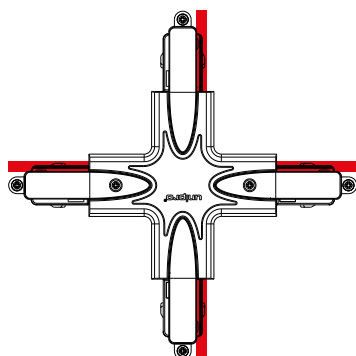

Please note! Earthing picture taken from below.



LUMINAIRE ADAPTER A75

Rated values for 3-phase lighting track system: 6A, 250V | Pull strength 5kg, with L70 locking lever 7kg.

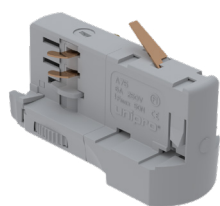

CODE	PRODUCT	WGT. kg / pce	COLOUR	PACKAGE
1459016	UNIPRO A75G	0.034	Grey	12 PCE / 1 BG

LUMINAIRE ADAPTER A79

Rated values for 3-phase lighting track system: 6A, 250V | Pull strength 5kg.

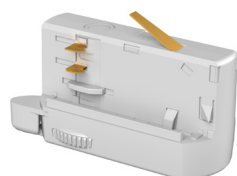

CODE	PRODUCT	WGT. kg / pce	COLOUR	PACKAGE
1459372	UNIPRO A79W	0.034	White	100 PCE / 1 BG
1459377	UNIPRO A79B	0.034	Black	100 PCE / 1 BG

LUMINAIRE ADAPTER A90

Rated values for 3-phase lighting track system: 6A, 250V | Pull strength 10kg.

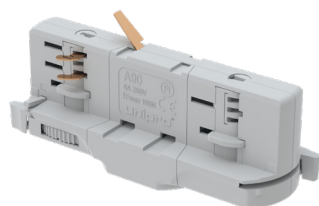

CODE	PRODUCT	WGT. kg / pce	COLOUR	PACKAGE
1459029	UNIPRO A90W	0.047	White	8 PCE / 1 BG
1459031	UNIPRO A90G	0.047	Grey	8 PCE / 1 BG
1459030	UNIPRO A90B	0.047	Black	8 PCE / 1 BG

CONTROL-DALI LUMINAIRE ADAPTER A90C

Rated values for Control-DALI system: 6A, 250V | FELV ≤50VAC ≤1A | Pull strength 10kg.

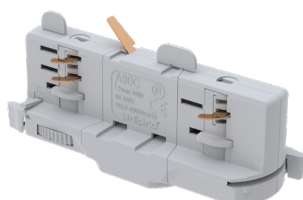

CODE	PRODUCT	WGT. kg / pce	COLOUR	PACKAGE
1459026	UNIPRO A90CW	0.047	White	8 PCE / 1 BG
1459028	UNIPRO A90CG	0.047	Grey	8 PCE / 1 BG
1459027	UNIPRO A90CB	0.047	Black	8 PCE / 1 BG

IN-TRACK DRIVER ADAPTER A201

29-42 W, length 270 mm, for 3-phase lighting track systems

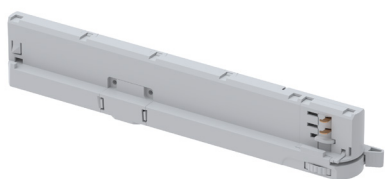

CODE	PRODUCT	WGT. kg / pce	COLOUR	PACKAGE
1459374	UNIPRO A201W	0.07	White	1 PCE
1459376	UNIPRO A201B	0.07	Black	1 PCE
1459373	UNIPRO A201G	0.07	Grey	1 PCE

IN-TRACK DRIVER ADAPTER A204CA

42 W, length 270 mm, for 3-phase lighting track systems including Casambi



CODE	PRODUCT	WGT. kg / pce	COLOUR	PACKAGE
1459298	UNIPRO A204CAW	0.07	White	1 PCE
1459299	UNIPRO A204CAB	0.07	Black	1 PCE
1459300	UNIPRO A204CAG	0.07	Grey	1 PCE

CONTROL-DALI IN-TRACK DRIVER ADAPTER A204C

42 W, length 270 mm, for 3-phase lighting track systems



CODE	PRODUCT	WGT. kg / pce	COLOUR	PACKAGE
1459295	UNIPRO A204CW	0.07	White	1 PCE
1459296	UNIPRO A204CB	0.07	Black	1 PCE
1459297	UNIPRO A204CG	0.07	Grey	1 PCE

POWER OUTLET ADAPTER A100

Power supply with 1-or 3-phase power, only compatible with unipro® 3-phase and Control-DALI lighting tracks. Cannot be used on DALI control.



CODE	PRODUCT	WGT. kg / pce	COLOUR	PACKAGE
1459011	UNIPRO A100W	0.065	White	6 PCE / 1 BG
1459013	UNIPRO A100G	0.065	Grey	6 PCE / 1 BG
1459012	UNIPRO A100B	0.065	Black	6 PCE / 1 BG

MONOPOINT FOR ADAPTER A75 MP

Rated values: 10A, 250V | Pull strength 5kg.

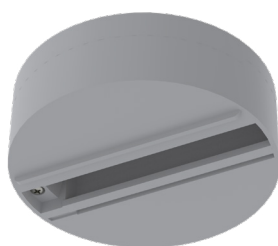

CODE	PRODUCT	WGT. kg / pce	COLOUR	PACKAGE
1459040	UNIPRO MP W	0.1	White	1 PCE
1459042	UNIPRO MP G	0.1	Grey	1 PCE
1459041	UNIPRO MP B	0.1	Black	1 PCE

INSTALLATION TOOL T1L

Tool for attaching wires to lighting adapters A75, A90 and A90C.



CODE	PRODUCT	WGT. kg / pce	COLOUR	PACKAGE
1459099	UNIPRO T1L	0.1	Grey	1 PCE

AL-NIPPLE M10 ALN

Lighting fixture for lighting adapter, M10 thread. Available thread lengths: 8mm and 12mm.



CODE	PRODUCT	WGT. kg / pce	COLOUR	PACKAGE
1459091	UNIPRO ALN10R8	0.005	Grey	100 PCE / 1 BG
1459092	UNIPRO ALN10R12	0.006	Grey	100 PCE / 1 BG

COUNTER NUT FOR AL-NIPPLE NM10

M10 locknut for ALN10.



CODE	PRODUCT	WGT. kg / pce	COLOUR	PACKAGE
1459428	UNIPRO NM10	0.01	Grey	100 PCE / 1 BG

CABLE CLAMP CC70

Strain relief for lighting adapter.



CODE	PRODUCT	WGT. kg / pce	COLOUR	PACKAGE
1459010	UNIPRO CC70	0.002	Grey	100 PCE / 1 BG

QUICK CEILING BRACKET QCB

Tool-less snap installation to lighting tracks. Can be used with wire suspension set WS or threaded rod GT-6 with extension nut. Pull strength 15kg.

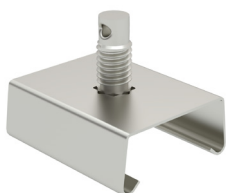

CODE	PRODUCT	WGT. kg / pce	COLOUR	PACKAGE
1459421	UNIPRO QCB W	0.008	White	10 PCE / 1 BG
1459422	UNIPRO QCB G	0.008	Grey	10 PCE / 1 BG
1459423	UNIPRO QCB B	0.008	Black	10 PCE / 1 BG

QUICK CONNECTOR QC3

Twist to fasten to lighting track. M6 screw on top, grey, can be used with wire suspension sets, and threaded rods with extension nut. Pull strength 8kg.



CODE	PRODUCT	WGT. kg / pce	COLOUR	PACKAGE
1459100	UNIPRO QC3G	0.008	Grey	10 PCE / 1 BG

CEILING BRACKET CB3

Steel ceiling clamp. Can be attached to wire suspension sets and threaded rods. Pull strength 20kg.

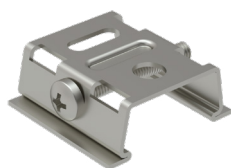

CODE	PRODUCT	WGT. kg / pce	COLOUR	PACKAGE
1459401	UNIPRO CB3W	0.014	White	10 PCE / 1 BG
1459402	UNIPRO CB3G	0.014	Grey	10 PCE / 1 BG
1459403	UNIPRO CB3B	0.014	Black	10 PCE / 1 BG

CEILING BRACKET FOR T-BAR CB3 T-BAR

Steel 24mm T-bar clamp. Pull strength 5kg.

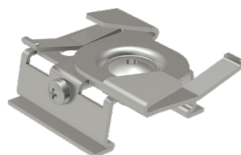

CODE	PRODUCT	WGT. kg / pce	COLOUR	PACKAGE
1459451	UNIPRO CB3W T-BAR	0.022	White	10 PCE / 1 BG
1459452	UNIPRO CB3G T-BAR	0.022	Grey	10 PCE / 1 BG
1459453	UNIPRO CB3B T-BAR	0.022	Black	10 PCE / 1 BG

PENDANT BRACKET PB

Steel pendant bracket. Used with hooked wire suspension set WS40H, or wire set WSL40. Pull strength 20kg.



CODE	PRODUCT	WGT. kg / pce	COLOUR	PACKAGE
1459407	UNIPRO PB W	0.02	White	10 PCE / 1 BG
1459408	UNIPRO PB G	0.02	Grey	10 PCE / 1 BG
1459409	UNIPRO PB B	0.02	Black	10 PCE / 1 BG

PENDANT COUPLER PC

Steel pendant bracket. Used on lighting track joints with hooked wire suspension set WS40H or WSL40.
Pull strength 20kg.



CODE	PRODUCT	WGT. kg / pce	COLOUR	PACKAGE
1459431	UNIPRO PC W	0.085	White	10 PCE / 1 BG
1459432	UNIPRO PC G	0.085	Grey	10 PCE / 1 BG
1459433	UNIPRO PC B	0.085	Black	10 PCE / 1 BG

WALL BRACKET WB

Steel wall bracket. Used with ceiling bracket CB3. Pull strength 3kg.



CODE	PRODUCT	WGT. kg / pce	COLOUR	PACKAGE
1459436	UNIPRO WB W	0.045	White	10 PCE / 1 BG
1459437	UNIPRO WB B	0.045	Black	10 PCE / 1 BG

SUSPENSION CLAMP SC3

Pull strength 10kg, for 3-phase and Control-DALI lighting tracks.



CODE	PRODUCT	WGT. kg / pce	COLOUR	PACKAGE
1459440	UNIPRO SC3W	0.065	White	10 PCE / 1 BG
1459441	UNIPRO SC3G	0.065	Grey	10 PCE / 1 BG
1459442	UNIPRO SC3B	0.065	Black	10 PCE / 1 BG

ADJUSTABLE WIRE SUSPENSION SET WS

Wire suspension set for CB3, QC3 and QCB brackets. Pull strength 15kg, WS40 W pull strength 12kg.

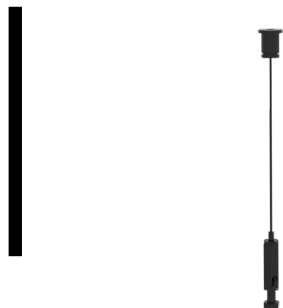

CODE	PRODUCT	WGT. kg / pce	LENGTH mm	COLOUR	PACKAGE
1459410	UNIPRO WS15	0.054	1500	Grey	1 PCE / 1 BG
1459415	UNIPRO WS15 B	0.05	1500	Black	1 PCE / 1 BG
1459411	UNIPRO WS40	0.08	4000	Grey	1 PCE / 1 BG
1459416	UNIPRO WS40 B	0.08	4000	Black	1 PCE / 1 BG
1459417	UNIPRO WS40 W	0.08	4000	White	1 PCE / 1 BG
1459412	UNIPRO WS60	0.11	6000	Grey	1 PCE / 1 BG

ADJUSTABLE WIRE SUSPENSION SET WITH HOOK WS40H

Wire suspension set for PB and PC brackets, pull strength 10kg.

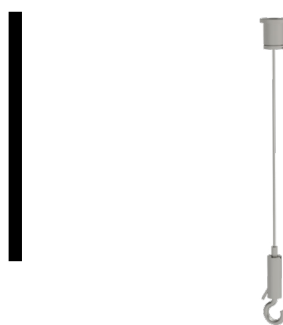

CODE	PRODUCT	WGT. kg / pce	LENGTH mm	COLOUR	PACKAGE
1459414	UNIPRO WS40H	0.08	4000	Grey	1 PCE / 1 BG

ADJUSTABLE WIRE SET WITH LOOP WIRE WS40L

Wire suspension set for CB3, QC3 and QCB brackets, pull strength 15kg.

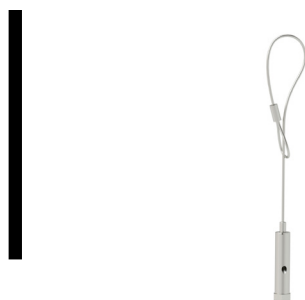

CODE	PRODUCT	WGT. kg / pce	LENGTH mm	COLOUR	PACKAGE
1459128	UNIPRO WS40L	0.05	4000	Grey	1 PCE / 1 BG
1459130	UNIPRO WS40L B	0.05	4000	Black	1 PCE / 1 BG

WIRE SET WITH ADJUSTABLE CEILING ATTACHMENT AND LOOP WIRE WSL40

Wire suspension set for PB and PC brackets, pull strength 15kg.



CODE	PRODUCT	WGT. kg / pce	LENGTH mm	COLOUR	PACKAGE
1459135	UNIPRO WSL40	0.05	4000	Grey	1 PCE / 1 BG
1459136	UNIPRO WSL40 B	0.05	4000	Black	1 PCE / 1 BG

Ø1.5 MM WIRE WITH LOOP WL40

Ø1.5mm wire with loop, pull strength 15 kg, to be used with e.g. a WG wire gripper.



CODE	PRODUCT	WGT. kg / pce	LENGTH mm	COLOUR	PACKAGE
1459146	UNIPRO WL40	0.05	4000	Grey	1 PCE / 1 BG
1459150	UNIPRO WL40 B	0.05	4000	Black	1 PCE / 1 BG

ADJUSTABLE WIRE GRIPPER WG

Cable lock for Ø1.5mm wires, pull strength 20kg.



CODE	PRODUCT	WGT. kg / pce	COLOUR	PACKAGE
1459140	UNIPRO WG	0.01	Grey	50 PCE
1459145	UNIPRO WG B	0.01	Black	50 PCE

WIRE REEL, Ø=1.5MM, L=50M WR

50 metre Ø1.5 mm cable spool, steel grey, pull strength 15 kg, to be used with e.g. a WG wire gripper.

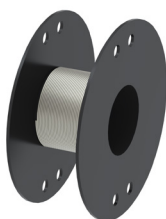

CODE	PRODUCT	WGT. kg / pce	LENGTH mm	COLOUR	PACKAGE
1459127	UNIPRO WR	0.8	50000	Grey	1 PCE / 1 BG

SUSPENSION HOOK SH

Pull strength 1kg, for SC3 suspension base.



CODE	PRODUCT	WGT. kg / pce	COLOUR	PACKAGE
1459443	UNIPRO SH	0.002	Grey	100 PCE / 1 BG

NUT MU / EXTENSION NUT JM

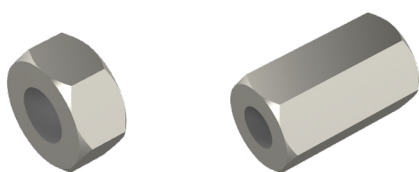

CODE	PRODUCT	WGT. kg / pce	COLOUR	PACKAGE
1459427	MU M6 EG	0.01	Grey	100 PCE / 1 BG

CODE	PRODUCT	WGT. kg / pce	COLOUR	PACKAGE
1459425	JM M6 EG	0.01	Grey	100 PCE / 1 BG



Helvar

Intelligence of ActiveAhead® Combined With the Benefits of DALI Addressing

Helvar's ActiveAhead® is now available with UNIPRO 3-phase DALI track system.

ActiveAhead® now connects to DALI devices and the benefits of this can now be brought into Unipro DALI lighting track solution.



5609

ActiveAhead® Node Advanced for DALI



CODE	PRODUCT	PACKAGE
113165	HELVAR 5609	1 PCE

320TR & 320BTR

PIR Sensor + A90C, white for DALI

PIR Sensor + A90C, black for DALI



CODE	PRODUCT	PACKAGE
113166	HELVAR 320TR	1 PCE
113167	HELVAR 320BTR	1 PCE

321TR & 321BTR

MULTISensor + A90C, white for DALI

MULTISensor + A90C, black for DALI



CODE	PRODUCT	PACKAGE
113168	HELVAR 321TR	1 PCE
113169	HELVAR 321BTR	1 PCE

322TR & 322BTR

High Bay MULTISensor + A90C, white for DALI

High Bay MULTISensor + A90C, black for DALI



CODE	PRODUCT	PACKAGE
113170	HELVAR 322TR	1 PCE
113171	HELVAR 322BTR	1 PCE

320D2TR & 320BD2TR

PIR Sensor (DALI-2) + A90C, white
PIR Sensor (DALI-2) + A90C, black



CODE	PRODUCT	PACKAGE
113172	HELVAR 320D2TR	1 PCE
113173	HELVAR 320BD2TR	1 PCE

321D2TR & 321BD2TR

MULTISensor (DALI-2) + A90C, white for DALI
MULTISensor (DALI-2) + A90C, black for DALI



CODE	PRODUCT	PACKAGE
113174	HELVAR 321D2TR	1 PCE
113175	HELVAR 321BD2TR	1 PCE

322D2TR & 322DTRB

High Bay MULTISensor (DALI-2) + A90C, white for DALI
High Bay MULTISensor (DALI-2) + A90C, black for DALI



CODE	PRODUCT	PACKAGE
113176	HELVAR 322D2TR	1 PCE
113177	HELVAR 322DTRB	1 PCE



making
your
lights
shne

UNIPRO OY LTD

ITÄPORTINTIE 1, 13430 HÄMEENLINNA, FINLAND
+358 207 450 800
WWW.UNIPRO.FI